

5KP-HF Series

Stand-off Voltage: 6.8V ~ 440V

Power Dissipation: 5000 Watts

RoHS Device

Halogen Free

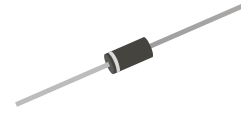

Features

- Glass passivated chip.
- Low leakage.
- Uni and Bidirection unit.
- Excellent clamping capability.
- The plastic material has UL recognition 94V-0.
- Fast response time.

Mechanical Data

- Case: Molded plastic R-6
- Lead: Solderable per MIL-STD-202, method 208 guaranteed.
- Polarity: Color band denotes cathode end except Bipolar.
- Mounting position: Any
- Weight: 2.1 grams

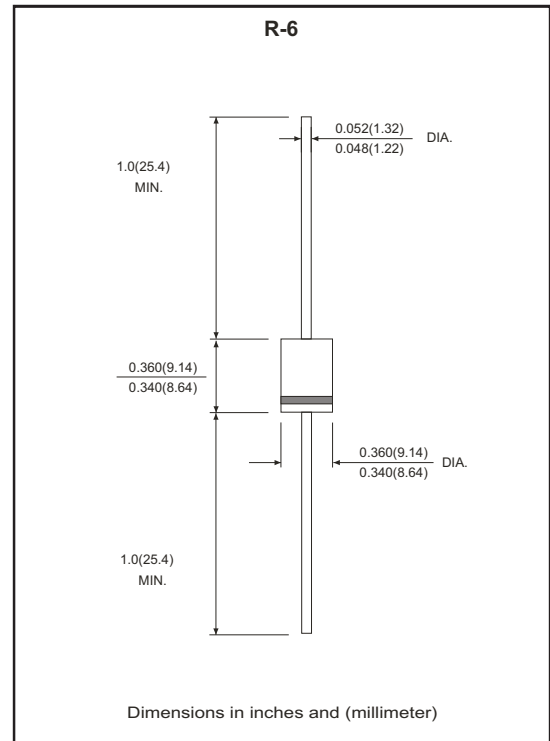

Maximum Ratings and Electrical Characteristics

Rating at 25°C ambient temperature unless otherwise specified.
Single phase, half wave, 60Hz, resistive or inductive loaded.
For capacitive load, derated current by 20%.

Parameter	Symbol	Value	Unit
Peak power dissipation with a 10/1000µs waveform (Note 1)	P _{PP}	5000	W
Peak pulse current with a 10/1000µs waveform (Note 1)	I _{PP}	See Next Table	W
Power dissipation on infinite heatsink at T _L =75°C	P _D	8.0	W
Peak forward surge current, 8.3ms single half sine-wave unidirectional only (Note 2)	I _{FSM}	500	A
Maximum instantaneous forward voltage at 100A for uni-directional devices only (Note 3)	V _F	3.5 / 5.0	V
Operating junction and storage temperature range	T _J , T _{STG}	-55 to +150	°C

NTOES:

- (1) Non-repetitive current pulse, per fig.5 and derated above T_A=25 °C per fig. 1.
- (2) Measured on 8.3 ms single half sine wave of equivalent square wave,duty cycle=4 pulses per minute maximum.
- (3) V_F<3.5V for devices of V_{BR}<200V and V_F<5.0V for devices of V_{BR}>201V

Company reserves the right to improve product design , functions and reliability without notice.

REV:B

RATING AND CHARACTERISTIC (5KP-HF Series)

Fig.1- Pulse Derating Curve

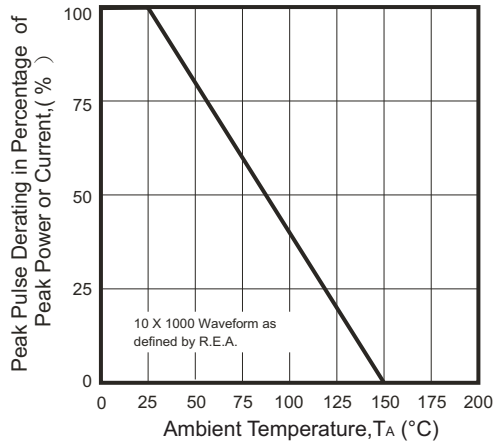

Fig.2- Maximum Non-Repetitive Surge Current

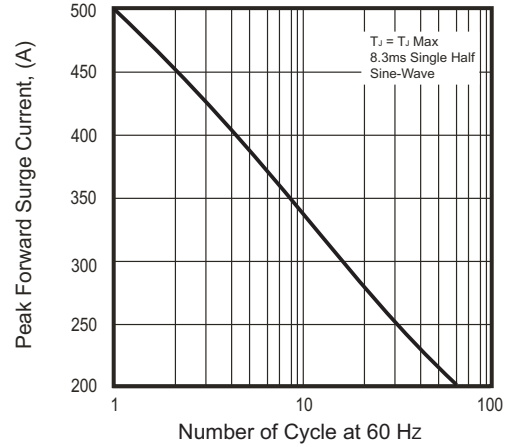

Fig.3- Steady State Power Derating Curve

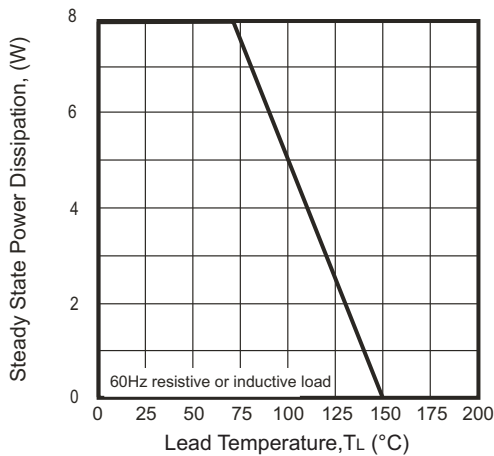

Fig.4- Peak Pulse Power Rating Curve

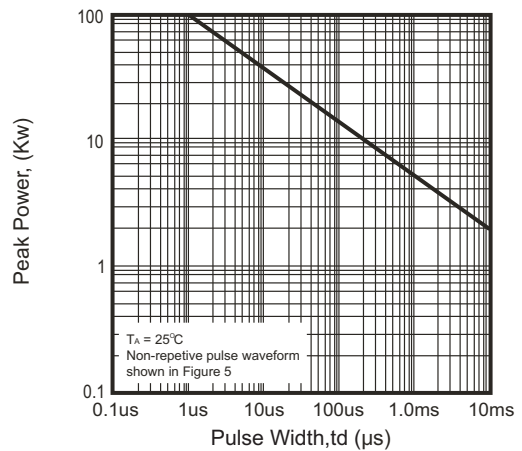

Fig.5- Pulse Waveform

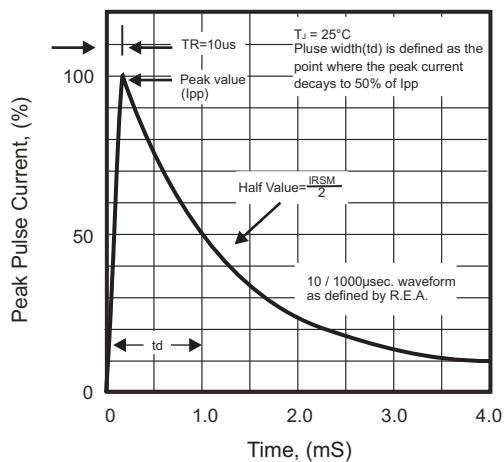
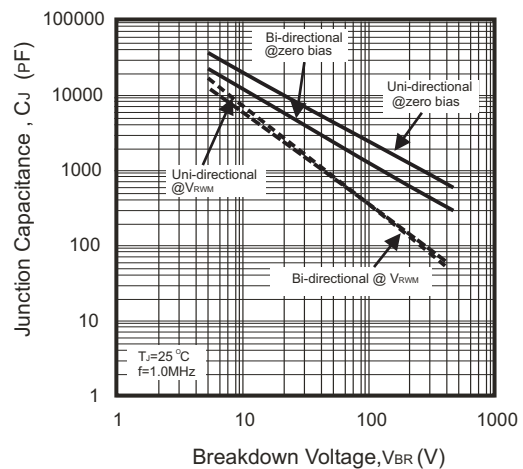

Fig.4- Typical Junction Capacitance



5000W Transient Voltage Suppressor



RATING AND CHARACTERISTIC (5KP-HF Series)

Part No.		Absolute Maximum Rating (Ta=25°C)					Electrical Characteristics (Ta=25°C)			Marking Code.	
Uni	Bi	V _{RWM}	V _{BR} Min.	V _{BR} Max.	I _T	I _{FSM}	Max. V _C @I _{PPM}		Max. I _R @V _{RWM}	Uni	Bi
		(V)	(V)	(V)	(mA)	(A)@8.3ms	(V)	I _{PPM} (A)	uA		
5KP5.0A-HF	5KP5.0CA-HF	5.0	6.40	7.00	50	500	9.2	543.48	5000	5KP5.0A	5KP5.0CA
5KP6.0A-HF	5KP6.0CA-HF	6.0	6.67	7.37	50	500	10.3	485.44	5000	5KP6.0A	5KP6.0CA
5KP6.5A-HF	5KP6.5CA-HF	7.0	7.22	7.98	50	500	11.2	446.43	2000	5KP6.5A	5KP6.5CA
5KP7.0A-HF	5KP7.0CA-HF	7.0	7.78	8.60	50	500	12.0	416.67	1000	5KP7.0A	5KP7.0CA
5KP7.5A-HF	5KP7.5CA-HF	8.0	8.33	9.21	5	500	12.9	387.60	250	5KP7.5A	5KP7.5CA
5KP8.0A-HF	5KP8.0CA-HF	8.0	8.89	9.83	5	500	13.6	367.65	150	5KP8.0A	5KP8.0CA
5KP8.5A-HF	5KP8.5CA-HF	9.0	9.44	10.40	5	500	14.4	347.22	50	5KP8.5A	5KP8.5CA
5KP9.0A-HF	5KP9.0CA-HF	9.0	10.00	11.10	5	500	15.4	324.68	20	5KP9.0A	5KP9.0CA
5KP10A-HF	5KP10CA-HF	10.0	11.10	12.30	5	500	17.0	294.12	15	5KP10A	5KP10CA
5KP11A-HF	5KP11CA-HF	11.0	12.20	13.50	5	500	18.2	274.73	2	5KP11A	5KP11CA
5KP12A-HF	5KP12CA-HF	12.0	13.30	14.70	5	500	19.9	251.26	2	5KP12A	5KP12CA
5KP13A-HF	5KP13CA-HF	13.0	14.40	15.90	5	500	21.5	232.56	2	5KP13A	5KP13CA
5KP14A-HF	5KP14CA-HF	14.0	15.60	17.20	5	500	23.2	215.52	2	5KP14A	5KP14CA
5KP15A-HF	5KP15CA-HF	15.0	16.70	18.50	5	500	24.4	204.92	2	5KP15A	5KP15CA
5KP16A-HF	5KP16CA-HF	16.0	17.80	19.70	5	500	26.0	192.31	2	5KP16A	5KP16CA
5KP17A-HF	5KP17CA-HF	17.0	18.90	20.90	5	500	27.6	181.16	2	5KP17A	5KP17CA
5KP18A-HF	5KP18CA-HF	18.0	20.00	22.10	5	500	29.2	171.23	2	5KP18A	5KP18CA
5KP19A-HF	5KP19CA-HF	19.0	21.10	23.30	5	500	30.8	162.44	2	5KP19A	5KP19CA
5KP20A-HF	5KP20CA-HF	20.0	22.20	24.5	5	500	32.4	154.32	2	5KP20A	5KP20CA
5KP22A-HF	5KP22CA-HF	22.0	24.40	26.90	5	500	35.5	140.85	2	5KP22A	5KP22CA
5KP24A-HF	5KP24CA-HF	24.0	26.70	29.50	5	500	38.9	128.53	2	5KP24A	5KP24CA
5KP26A-HF	5KP26CA-HF	26.0	28.90	31.90	5	500	42.1	118.76	2	5KP26A	5KP26CA
5KP28A-HF	5KP28CA-HF	28.0	31.10	34.40	5	500	45.4	110.13	2	5KP28A	5KP28CA
5KP30A-HF	5KP30CA-HF	30.0	33.30	36.80	5	500	48.4	103.31	2	5KP30A	5KP30CA
5KP33A-HF	5KP33CA-HF	33.0	36.70	40.60	5	500	53.3	93.81	2	5KP33A	5KP33CA
5KP36A-HF	5KP36CA-HF	36.0	40.00	44.20	5	500	58.1	86.06	2	5KP36A	5KP36CA
5KP40A-HF	5KP40CA-HF	40.0	44.40	49.10	5	500	64.5	77.52	2	5KP40A	5KP40CA
5KP43A-HF	5KP43CA-HF	43.0	47.80	52.80	5	500	69.4	72.05	2	5KP43A	5KP43CA
5KP45A-HF	5KP45CA-HF	45.0	50.00	55.30	5	500	72.7	68.78	2	5KP45A	5KP45CA
5KP48A-HF	5KP48CA-HF	48.0	53.30	58.90	5	500	77.4	64.60	2	5KP48A	5KP48CA
5KP51A-HF	5KP51CA-HF	51.0	56.70	62.70	5	500	82.4	60.68	2	5KP51A	5KP51CA
5KP54A-HF	5KP54CA-HF	54.0	60.00	66.30	5	500	87.1	57.41	2	5KP54A	5KP54CA
5KP58A-HF	5KP58CA-HF	58.0	64.40	71.20	5	500	93.6	53.42	2	5KP58A	5KP58CA
5KP60A-HF	5KP60CA-HF	60.0	66.70	73.70	5	500	96.8	51.65	2	5KP60A	5KP60CA
5KP64A-HF	5KP64CA-HF	64.0	71.10	78.60	5	500	103.0	48.54	2	5KP64A	5KP64CA
5KP70A-HF	5KP70CA-HF	70.0	77.80	86.00	5	500	113.0	44.25	2	5KP70A	5KP70CA
5KP75A-HF	5KP75CA-HF	75.0	83.30	92.10	5	500	121.0	41.32	2	5KP75A	5KP75CA
5KP78A-HF	5KP78CA-HF	78.0	86.70	95.80	5	500	126.0	39.68	2	5KP78A	5KP78CA
5KP80A-HF	5KP80CA-HF	80.0	88.80	97.60	5	500	129.6	38.58	2	5KP80A	5KP80CA
5KP85A-HF	5KP85CA-HF	85.0	94.40	104.00	5	500	137.0	36.50	2	5KP85A	5KP85CA

Company reserves the right to improve product design , functions and reliability without notice.

REV.B

5000W Transient Voltage Suppressor

RATING AND CHARACTERISTIC (5KP-HF Series)

Part No.		Absolute Maximum Rating (Ta=25°C)					Electrical Characteristics (Ta=25°C)			Marking Code.	
Uni	Bi	V _{RWM}	V _{BR} Min.	V _{BR} Max.	I _T	I _{FSM}	Max. V _C @I _{PPM}		Max. I _R @V _{RWM}	Uni	Bi
		(V)	(V)	(V)	(mA)	(A)@8.3mS	(V)	I _{PPM} (A)	uA		
5KP90A-HF	5KP90CA-HF	90.0	100.00	111.00	5	500	146.0	34.25	2	5KP90A	5KP90CA
5KP100A-HF	5KP100CA-HF	100.0	111.00	123.00	5	500	162.0	30.86	2	5KP100A	5KP100CA
5KP110A-HF	5KP110CA-HF	110.0	122.00	135.00	5	500	177.0	28.25	2	5KP110A	5KP110CA
5KP120A-HF	5KP120CA-HF	120.0	133.00	147.00	5	500	193.0	25.91	2	5KP120A	5KP120CA
5KP130A-HF	5KP130CA-HF	130.0	144.00	159.00	5	500	209.0	23.92	2	5KP130A	5KP130CA
5KP140A-HF	5KP140CA-HF	140.0	155.00	171.00	5	500	226.8	22.05	2	5KP140A	5KP140CA
5KP150A-HF	5KP150CA-HF	150.0	167.00	185.00	5	500	243.0	20.58	2	5KP150A	5KP150CA
5KP160A-HF	5KP160CA-HF	160.0	178.00	197.00	5	500	259.0	19.31	2	5KP160A	5KP160CA
5KP170A-HF	5KP170CA-HF	170.0	189.00	209.00	5	500	275.0	18.18	2	5KP170A	5KP170CA
5KP180A-HF	5KP180CA-HF	180.0	200.00	220.00	5	500	291.6	17.15	2	5KP180A	5KP180CA
5KP190A-HF	5KP190CA-HF	190.0	211.00	232.00	5	500	307.8	16.24	2	5KP190A	5KP190CA
5KP200A-HF	5KP200CA-HF	200.0	224.00	247.00	5	500	324.0	15.43	2	5KP200A	5KP200CA
5KP210A-HF	5KP210CA-HF	210.0	233.00	258.00	5	500	349.5	42.10	2	5KP210A	5KP210CA
5KP220A-HF	5KP220CA-HF	220.0	246.00	272.00	5	500	356.0	50.00	2	5KP220A	5KP220CA
5KP250A-HF	5KP250CA-HF	250.0	279.00	309.00	5	500	405.0	45.40	2	5KP250A	5KP250CA
5KP300A-HF	5KP300CA-HF	300.0	335.00	371.00	5	500	486.0	53.50	2	5KP300A	5KP300CA
5KP350A-HF	5KP350CA-HF	350.0	391.00	432.00	5	500	567.0	48.4	2	5KP350A	5KP350CA
5KP400A-HF	5KP400CA-HF	400.0	447.00	494.00	5	500	648.0	7.72	2	5KP400A	5KP400CA
5KP440A-HF	5KP440CA-HF	440.0	492.00	543.00	5	500	713.0	7.01	2	5KP440A	5KP440CA

NOTES:

- Suffix 'A' denotes 5% tolerance device.
- Add suffix 'C' or 'CA' after part number to specify Bi-directional devices.
- For Bi-Directional devices having V_R of 10 Volts and under, the I_R Limit is double.

Taping Specification For Axial Lead Diodes

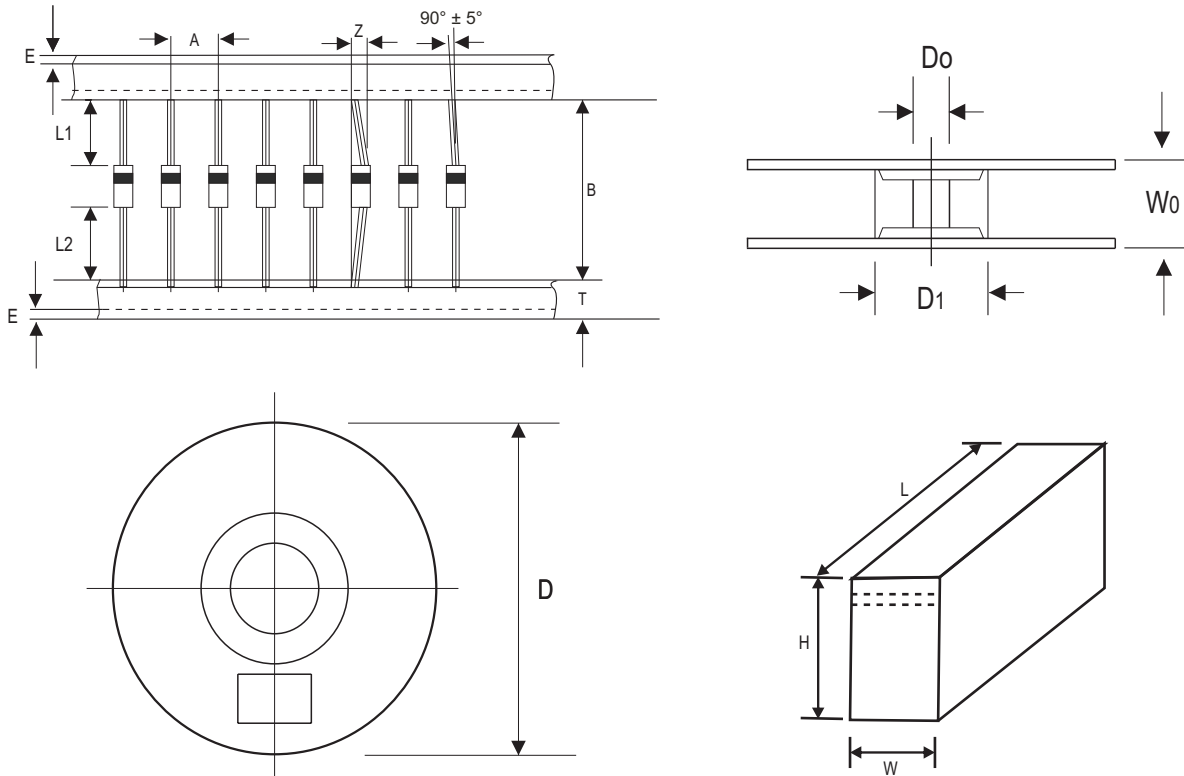

R-6	SYMBOL	A	B	Z	T	E	L1	L2
	(mm)	10.00 ± 0.50	52.00 ± 0.50	1.20 (max)	6.00 ± 0.40	1.00 (max)	1.00 (max)	1.00 (max)
	(inch)	0.394 ± 0.020	2.047 ± 0.020	0.047 (max)	0.236 ± 0.016	0.039 (max)	0.039 (max)	0.039 (max)

R-6	SYMBOL	D1	D0	D	W0	L	W	H
	(mm)	85.70 ± 0.30	16.60 ± 0.40	330.00	72.00 ± 3.00	260.00	75.00	145.00
	(inch)	3.374 ± 0.012	0.654 ± 0.016	13.000	2.835 ± 0.118	10.236	2.953	5.709

Standard Packaging

Case Type	AMMO PACK	
	BOX (pcs)	CARTON (pcs)
R-6	250	3,750